

**KLEWE**  
SISTEMASOLARE

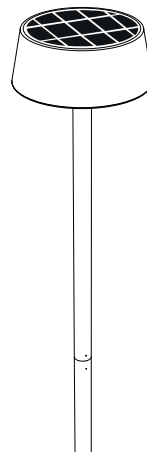

**SUNDRESS**



MADE IN CHINA

DESIGNED IN ITALY BY FRANCO PAGLIARINI  
[WWW.KLEWESOLAR.EU](http://WWW.KLEWESOLAR.EU)

VERSION 1.0 

1.



2.



3.

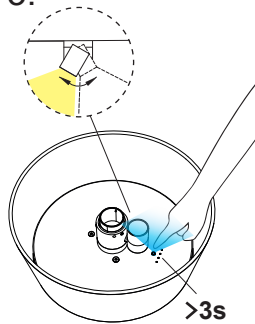

4.

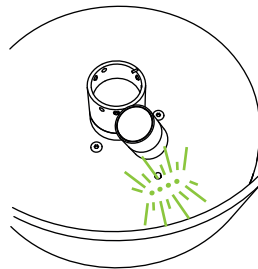

5.



6.



7.

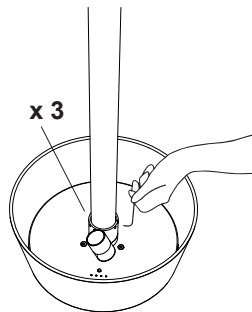

8.

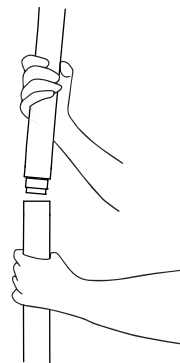

9.

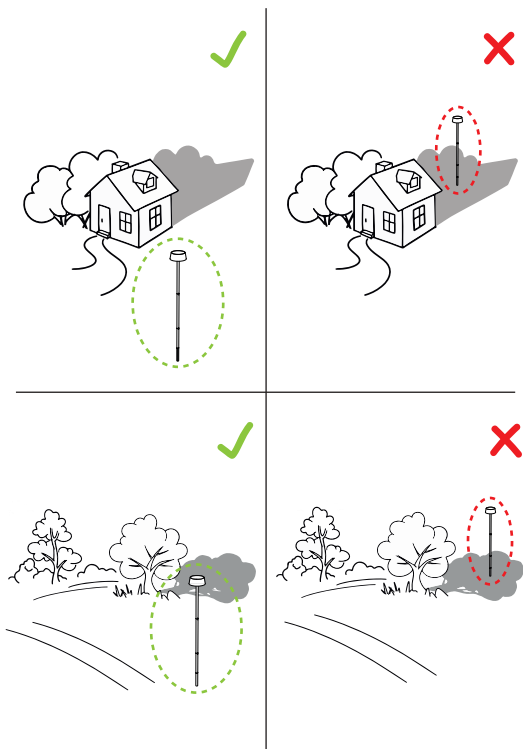
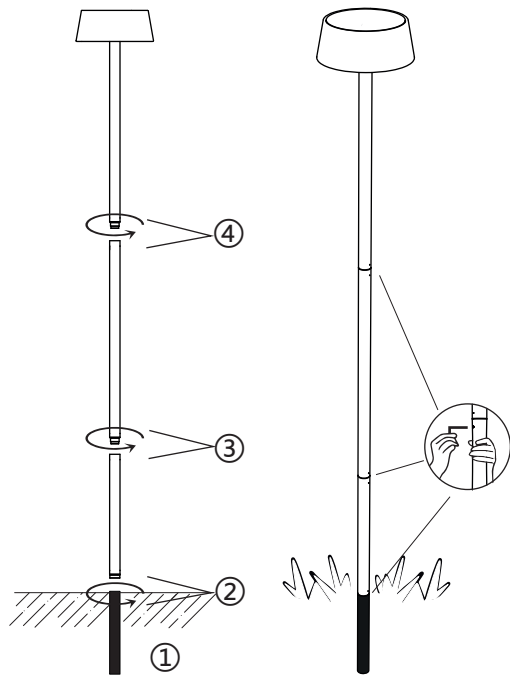

< 50LUX

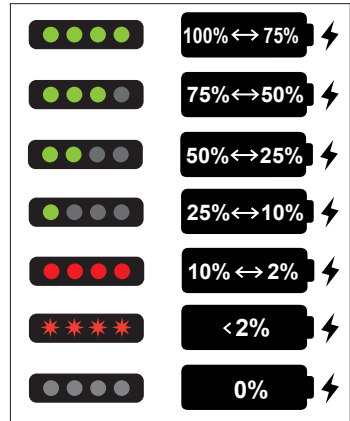
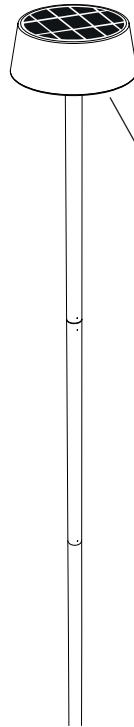
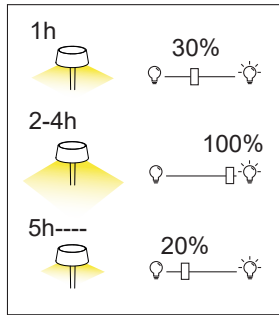
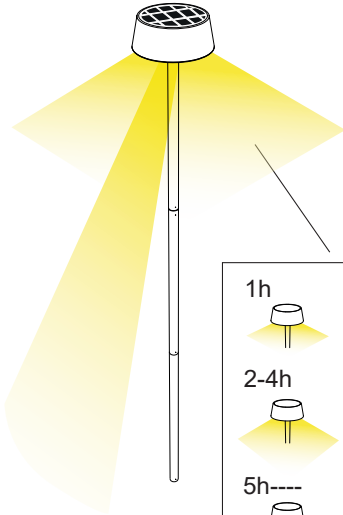

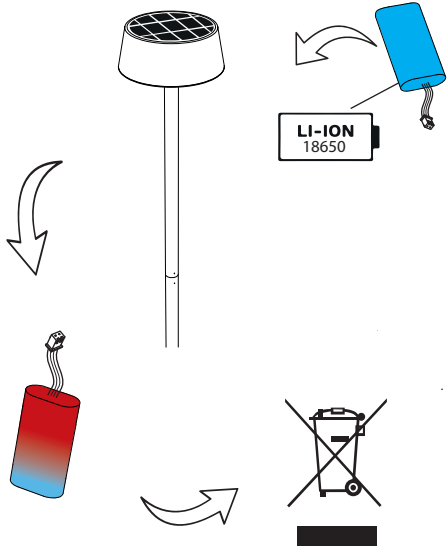
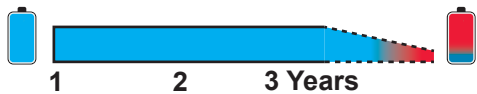

1.

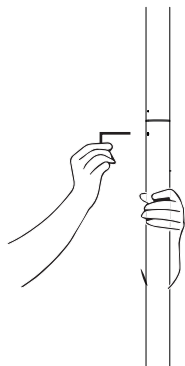

2.

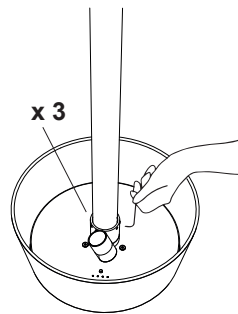

3.



4.

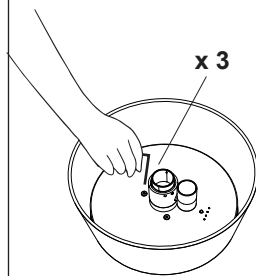

5.

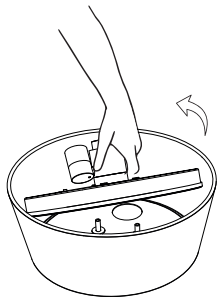

6.

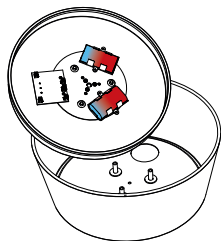

7.

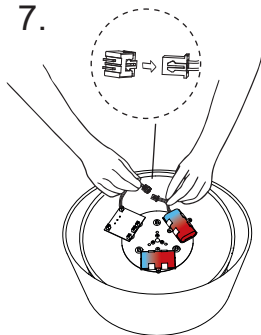

8.

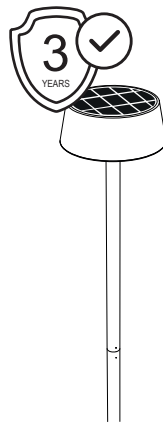
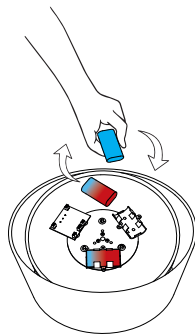

	IP65
	8-10h
	29-31h
Watt	4.4
	8800 mAh
	7.5W 7V
	3000K
CRI	>80



[info@klewesolar.eu](mailto:info@klewesolar.eu)