

KLEWE
SISTEMASOLARE

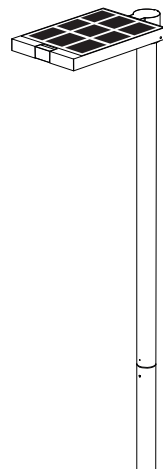

LINK



MADE IN CHINA

DESIGNED IN ITALY BY FRANCO PAGLIARINI
WWW.KLEWESOLAR.EU

VERSION 1.0 

1.

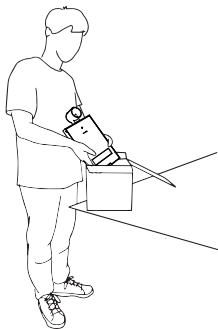

2.

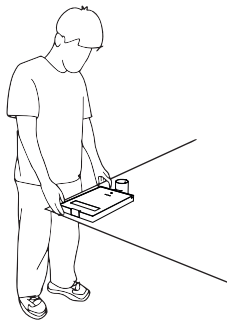

5A.

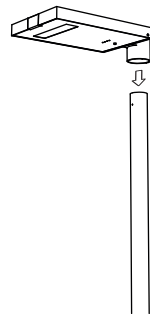
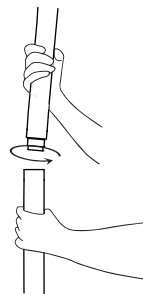
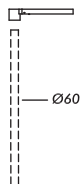

3.

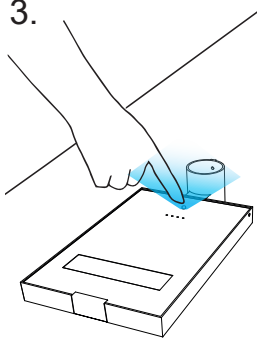

4.

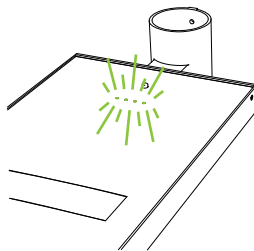

5B.

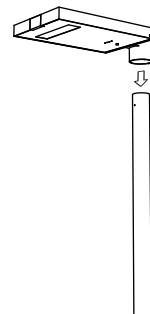
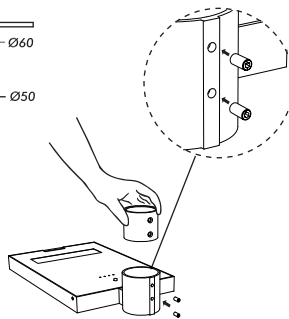
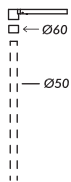

5B.

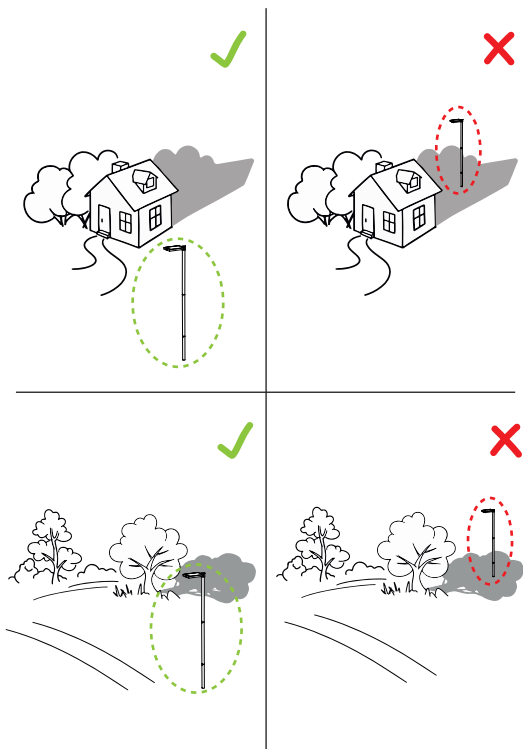
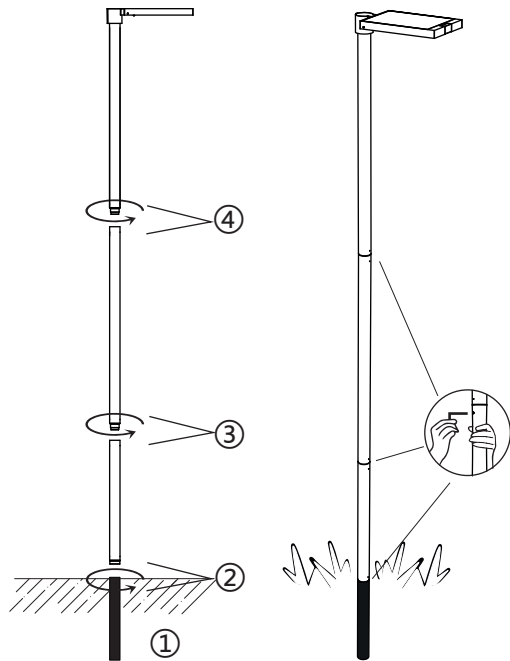

< 50LUX

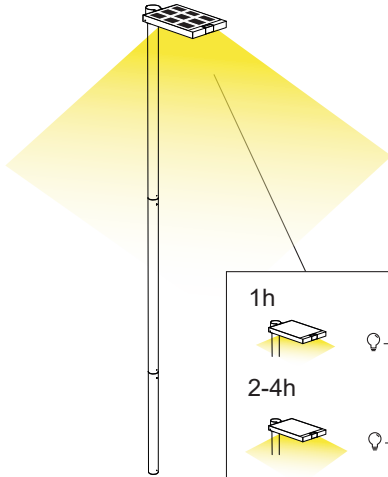

1h		30%	
2-4h		100%	
5h----		20%	

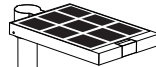

	100% ↔ 75%	
	75% ↔ 50%	
	50% ↔ 25%	
	25% ↔ 10%	
	10% ↔ 2%	
	< 2%	
	0%	

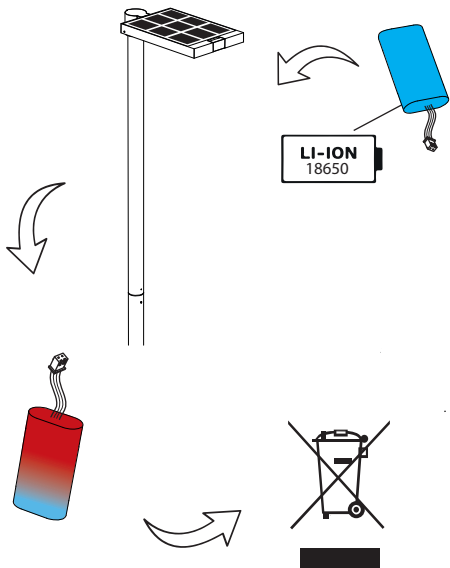
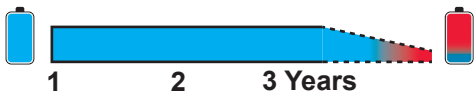

1.

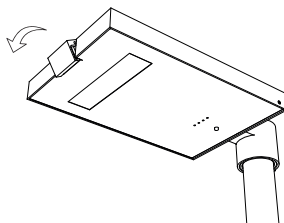

2.

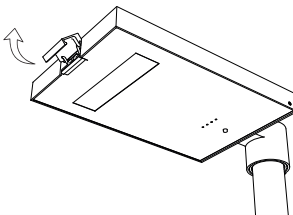

3.

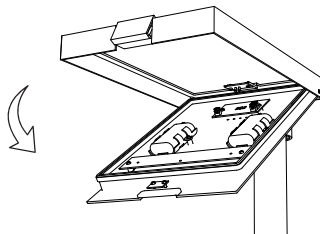

4.

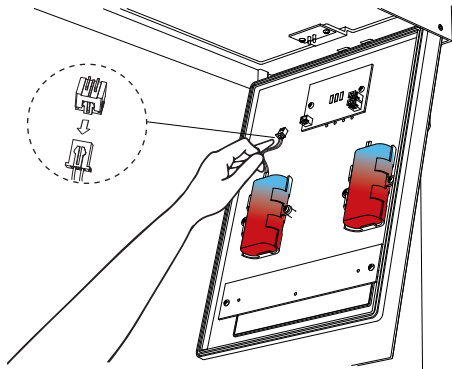

5.

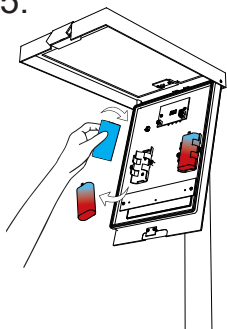

6.

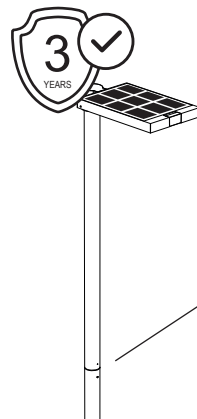
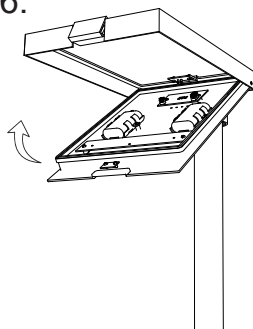

	IP65
	8-10h
	34-36h
Watt	5
	8800 mAh
	9W 7V
	3000K
CRI	>80



info@klewesolar.eu