

 **KLEWE**
SISTEMASOLARE

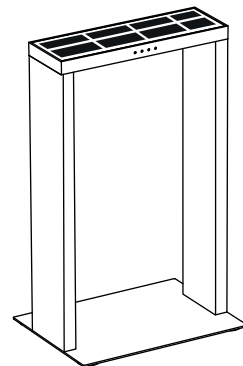

AXIS



MADE IN CHINA

DESIGNED IN ITALY BY FRANCO PAGLIARINI
WWW.KLEWESOLAR.EU

VERSION 1.0 

1.

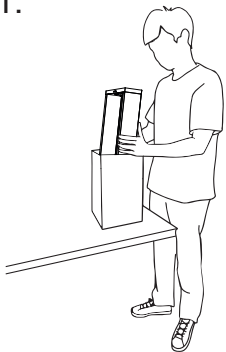

2.

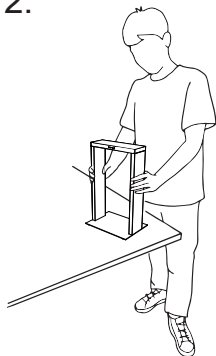

3.

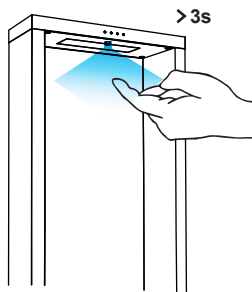

4.

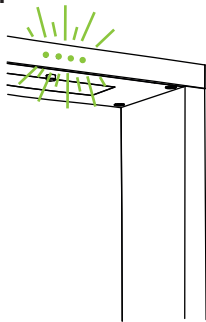



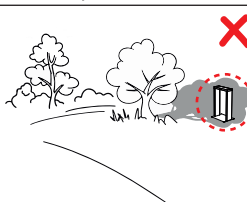
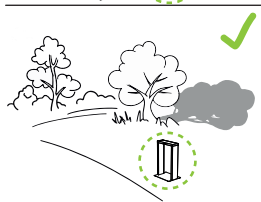
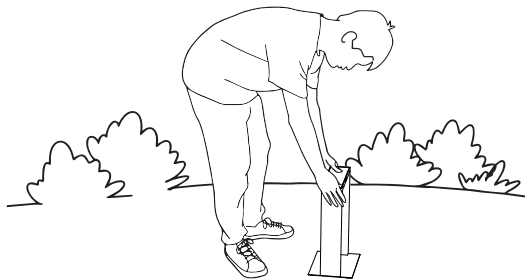



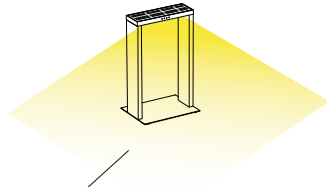

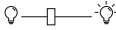



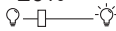





5.



< 50LUX



1h	30%
	
2-4h	100%
	
5h----	20%
	

	100% ↔ 75%	
	75% ↔ 50%	
	50% ↔ 25%	
	25% ↔ 10%	
	10% ↔ 2%	
	< 2%	
	0%	

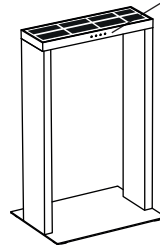

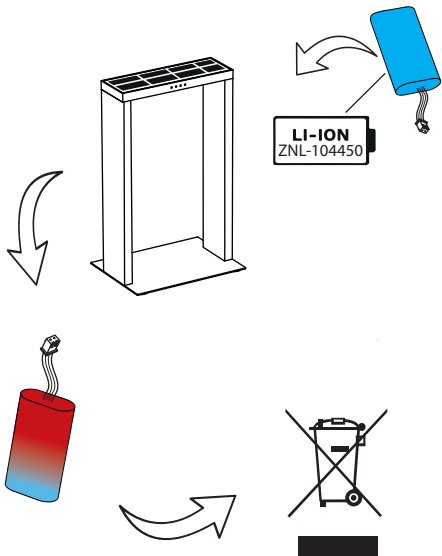
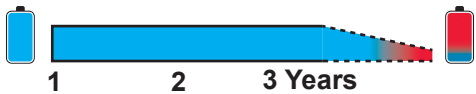

1.

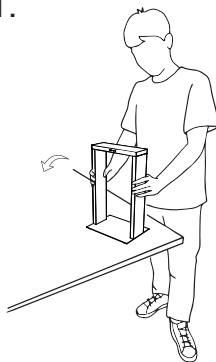

3.

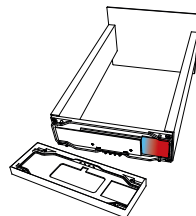

2.

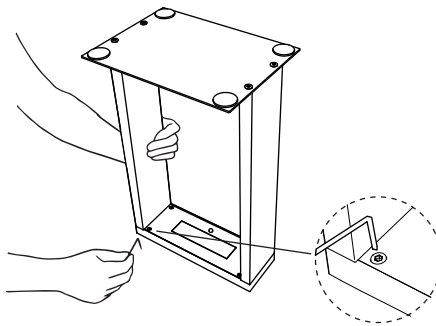

4.

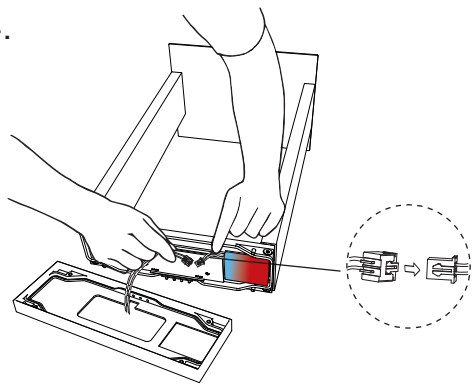

5.

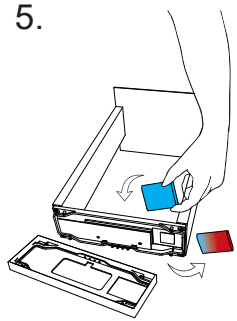

6.

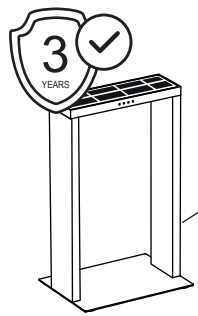
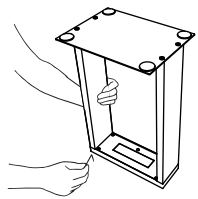

◆▲▲	IP65
⚡	10-12h
💡	19-21h
Watt	2.5
LI-ION	3000 mAh
☀️	2.5W 7V
💡	3000K
CRI	>80



info@klewesolar.eu